



MORLEY  **IAS**
FIRE SYSTEMS

by Honeywell

Fire Detection Systems Guide

Select Morley-IAS for a real choice



A large, stylized graphic of a flame in shades of blue and light blue, positioned on the left side of the page. It has a soft, ethereal appearance with a gradient from light blue to white.

contents

conventional fire alarm systems

4

intelligent fire alarm systems

9

detector application guide

15

conventional fire alarm systems

principle of operation

A conventional fire alarm system normally consists of a control panel linked to a number of lines of fire detectors and manual call points, normally called detection zones, and a number of sounder or alarm circuits. A simple system is shown in Figure 1.

control panel

The control panel drives the detection zones and sounder circuits, provides LED indications of fire, fault or normal conditions and contains switches to allow the sounders to be activated or silenced and the detectors to reset following an alarm. The control panel is powered from the mains (230VAC) and will contain back-up batteries to allow the system to function for

a minimum of 24 hours, dependant on the application, in case of a mains failure.

Note: There are numerous suppliers of fire control equipment and fire detection devices. There is no guarantee that all panels and all detectors are electrically compatible. Therefore, to avoid potential incompatibility issues, it is strongly recommended to purchase both groups of products from the same source, or to obtain confirmation of compatibility from the panel manufacturer.

fire detection and alarm zones

Most conventional fire alarm panels have several detection zones comprising a mixture of automatic fire detectors and manual call points. In order to limit the effect of faults, and to limit the search area in the case of a fire, the size of a fire detection zone is limited to 2000m², with a maximum travel distance within the zone to locate a fire of 60m. In addition, zones should not cover more than one storey, unless the total floor area of the building is less than 300m². As a result unless the site is very small, the system will comprise several detection zones.

A fire alarm (or sounder) circuit may cover more than one detection zone, but it must follow the boundaries of the relevant detection zones, and the boundaries should be of fire resisting construction.

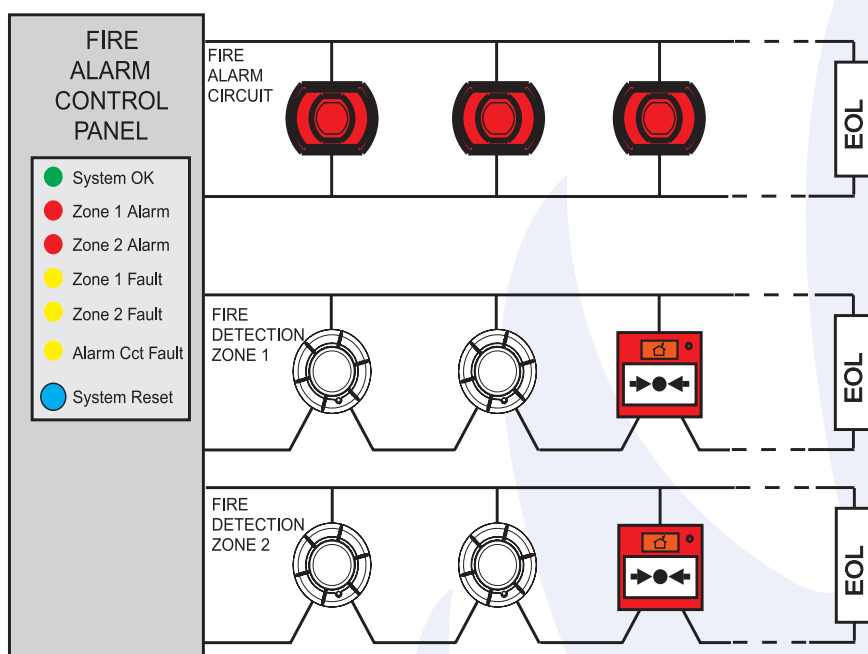

Figure 1: Simple conventional fire alarm system

conventional system operation

detection line operation

Conventional detection systems normally operate on a 24VDC line. In the standby condition, the detectors will draw a low current, typically less than 100µA. When the detector senses a fire, it will switch into the alarm condition with its LED illuminated, and will collapse the line voltage by drawing a larger current - dependant on the detectors and control panel, but typically 50-80mA. The control panel can sense this, and activate the appropriate alarms. The detector will remain latched in the alarm state with its LEDs illuminated, even if the smoke or heat is removed until it has been reset from the panel by momentarily removing power from the line. This allows the fire to be located even if the signal is intermittent, or to locate possible sources of nuisance alarms.

For some control panel - detector combinations, when a standard base is used, there is an incompatibility between the current specifications of the detector and panel, leading to incorrect reporting by the control panel, for example signalling a fault in place of an alarm, and in some cases damage to the detector due to over current in the alarm state. In these cases it is necessary to use a base fitted with a resistor in series with the

detector to limit the current draw in alarm. Resistors fitted into the detector base are also used in some cases to distinguish between a short circuit fault and an alarm. The value of the base resistor is dependant on the control panel, however a typical value is 470 Ohms. If in any doubt, contact the control panel manufacturer who should be able to specify which detector bases should be used with different detector brands.

A manual call-point consists of a simple switch with a resistor in series with it, usually 470 Ohms or 680 Ohms. When the call point is activated, the resistor is switched across the line, and a current of 50-80mA, dependant on the control panel, is drawn.

detection line fault monitoring

Standard conventional systems are able to monitor the zone for short circuit, open circuit and detector head removal.

When a short circuit occurs on a zone, a high current will be drawn, and the line voltage will be pulled towards zero volts. The panel detects the low voltage /high current and a fault is signalled.

In order to detect an open circuit, or detector head removal, a device is connected across the end of the zone, which can be monitored. This device can take various forms dependant on the control panel.

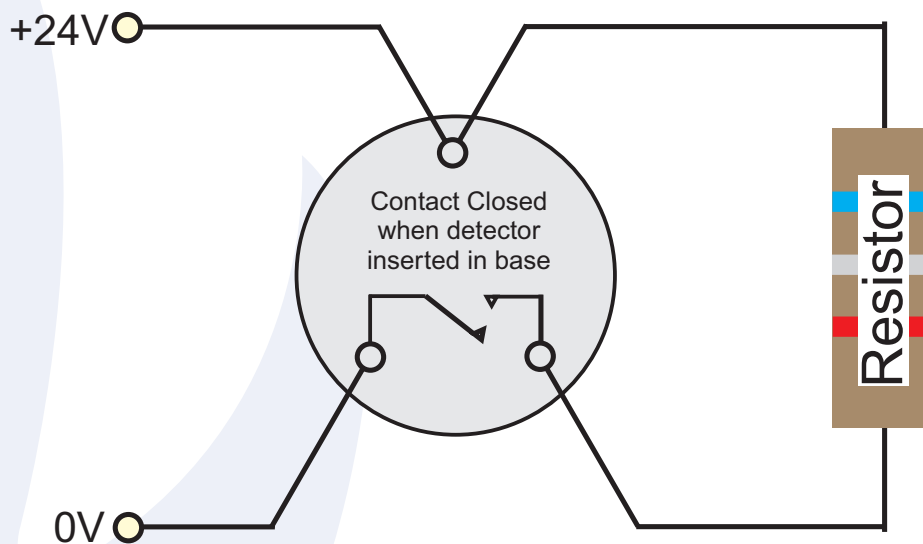

Figure 2: Resistive end of line operation

The simplest end of line device is a resistor, which will draw a current distinct from the quiescent and alarm currents drawn by the detectors. Installation of detectors into their bases closes a contact in the base supplying the remainder of the zone. Thus if the line is broken, or if a detector head is removed, the current drawn by the zone will fall, and a fault will be signalled (See figure 2). Example zone current and voltage figures are given in figure 3.

removed detector, it will no longer work, which contravenes the requirements of BS5839 part 1. To overcome this either all call points must be mounted at the start of each zone, or in completely separate zones (both of these solutions are often impractical and too costly), or head removal monitoring can be employed.

Active monitoring uses bases fitted with a diode across the contact in the base (fig 4). Whilst the detector

head is removed, the diode is connected across the contact, allowing power to continue to be supplied to the remainder of the zone, whilst still permitting the removed detector to be monitored. This is achieved in a number of ways.

An active end of line device uses a switched resistor at the end of line and can thus be used with a standard control panel. It sends a periodic signal back along the detection line, which is normally quenched by the control panel. When a head is removed, the base diode is switched into the line, and pulse can be seen. The Active end of line then switches the resistor out of the line, and a fault is signalled.

If a capacitive end of line is used, the panel periodically drops the line voltage for a few milliseconds, and looks for the line voltage being held up by the capacitor. When a head is removed, the panel will see the line voltage drop immediately as the capacitor's discharge will be inhibited by the diode, and thereby a fault can be signalled.

A third type of end of line device is a diode. With this the panel periodically reverses the line voltage for a few milliseconds: If the line is broken by the diode in the detector base, then no current can flow in the reverse direction.

The type of end of line monitoring used on a system will depend on the control panel. However it is important, particularly when using active end of line monitoring

Monitoring of detection line (example only)		
Condition	Current	Voltage
Open Circuit	<3mA	24V
Normal	5mA (dependant on EOL device)	18V
Fire	50mA (dependant on control panel)	4-15V
Short Circuit	High (dependant on control panel)	0V

Figure 3: Example resistive conventional system current and voltage figures

The problem with a simple resistive end of line is that should a detector head be removed, the remainder of the zone beyond that detector is lost and no alarm can be signalled beyond this point. Should a call point be mounted beyond the

is mounted in the base, the base contact connects directly across the diode, and links it out. There is usually provision for manually linking the diode out to permit continuity testing during commissioning. When the detector

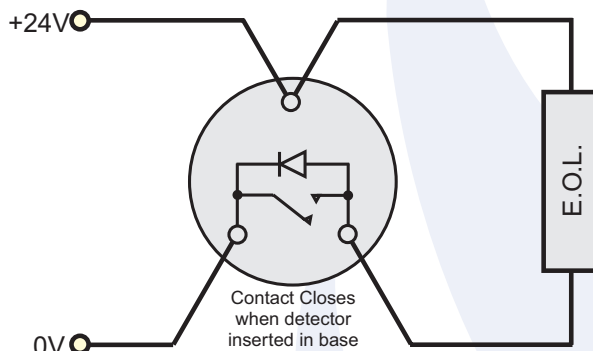

Figure 4: Active end of line monitoring circuit

to ensure that the detectors are compatible with the type of monitoring being used. Reference must be made to the panel manufacturer to ensure compatibility.

remote LEDs

Most system smoke detectors are equipped with a terminal to allow the connection of a remote LED. Remote LEDs are often used outside bedroom doors in hotels so that in case of a fire, it is easy for the fire brigade to identify the location of the fire without needing to enter every room in the building. They may also be used where a detector is located in a hidden position, such as a floor or roof void or cable tunnel, for example, to provide a visual indication that the detector is in an alarm state.

four-wire system operation

In some cases it is necessary that the power to the detectors and the fire detection signal be on separate

wires, see figure 5. In this instance, a base incorporating a change over relay is used. This configuration is known as a four-wire system, and is often seen when a fire zone is integrated into a security panel.

Figure 5 shows the simplest form of four-wire system, as used with most security panels. This is used where the monitor line is able only to register an open or closed circuit - there is no distinction between a fault and a fire. By using a normally closed relay at the end of the power line, it is possible to monitor for a power failure to the detectors. The

relay contacts are wired in series with the normally closed contacts of the detector relay base(s). Thus in the normal state the detection circuit is closed; in the case of fire or power failure the relevant relay contacts will open.

Normally after an alarm, the detectors are reset by disconnecting the power to the relevant zone for a short period by pressing a central panel reset button. Fire panels have this facility built in, however many security panels are unable to do this without turning the entire panel off. Therefore to allow the use of

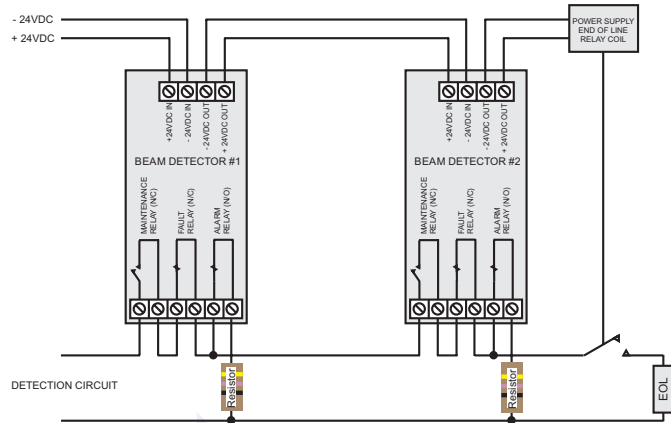

Figure 6: 4-wire system with full monitoring

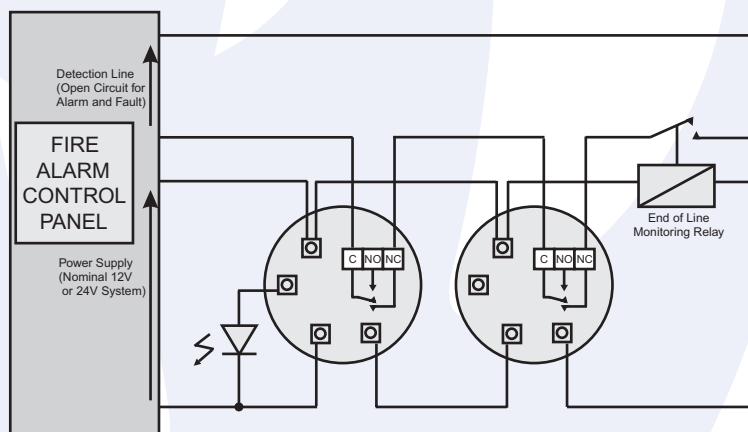

Figure 5: Typical 4 wire system wiring

detectors with security panels, non-latching versions of the relay bases are usually made available, which automatically isolate the detector from the supply every few seconds. Thus once the fire condition has passed the detector will automatically reset (note that the alarm condition should be latched at the control panel.)

Four-wire type systems are also often used with devices such as beam detectors where an auxiliary

power supply may be required. In this case if the device is connected to a fire control panel, able to distinguish between different detector states, the circuit can be routed to provide full monitoring for alarm and fault. Figure 6 shows typical wiring for a beam detector, which includes its own internal maintenance and fault monitoring. With this layout all fault and maintenance contacts are wired in series, and all alarm contacts in parallel with the end of line device. In the case of a fault or maintenance signal, the end of line will be disconnected, and a fault can be signalled at the panel. To distinguish between an alarm and short circuit, a resistor, typically

470 Ohms is placed in series with each alarm contact as indicated in order to shunt the detector zone. Note that a separate reset signal may be required to reset some beam detectors

fire alarm (sounder) zone operation

Similarly to detection lines, it is important to monitor fire alarm zones to ensure that the cable has not been broken, disconnected or shorted. However the operation of alarm zones is different from detection lines.

Fire alarm sounders contain a polarising diode, which allows them

to operate when a voltage is applied in one direction, but not when the voltage is reversed. When the system is in standby, the panel applies a voltage in the 'wrong' direction, so that the sounders do not operate and do not draw any current. An end-of-line resistor draws a constant monitoring current, which allows the panel to verify that the wiring is intact. Should the panel sense that no current is being drawn, it signals an open circuit fault. In the case of a short circuit, a high current is drawn from the zone, the voltage drops towards zero and a fault condition is shown. To activate the sounders, the control panel reverses the polarity of the voltage to the zone.

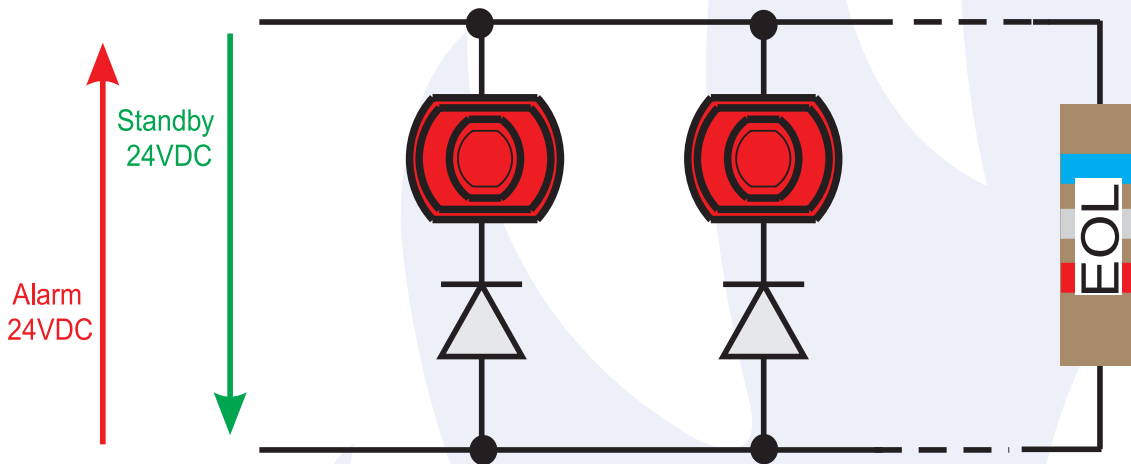

Figure 7: Conventional fire alarm sounder circuit

intelligent fire alarm systems

introduction

Conventional fire alarm systems provide an adequate and cost effective fire alarm system for many small buildings. In larger, more complex buildings however, more sophisticated 'intelligent' fire alarm systems tend to be used. These systems offer benefits in speed of detection, identification of the location of a fire and easier maintenance. Intelligent systems also offer tolerance to faults in the system wiring, which allows a single

pair of wires to be used to connect a large number of devices to the system, allowing cost savings in the wiring of large systems. In larger installations, the benefits of improved maintenance and reduced cabling cost are overwhelming. Currently, the point at which an intelligent system becomes economical is around 6 zones in the UK.

This guide is intended as an introduction to the technology used in intelligent fire alarm systems.

Figure 8 demonstrates an example of a single loop intelligent fire system layout. The wiring is looped, and connects to the control panel at each end. All detectors, call points, sounders and interface modules are wired directly to the loop, each having its own address.

The control panel communicates with each device on the loop, and if an alarm or fault condition is signalled, or if communications are lost with one or more detectors, the appropriate response is triggered. The loop can be powered from each end so that if the loop is broken at any point, no devices are lost. In addition the use of short circuit isolators minimises the area of coverage lost in the case of a short circuit.

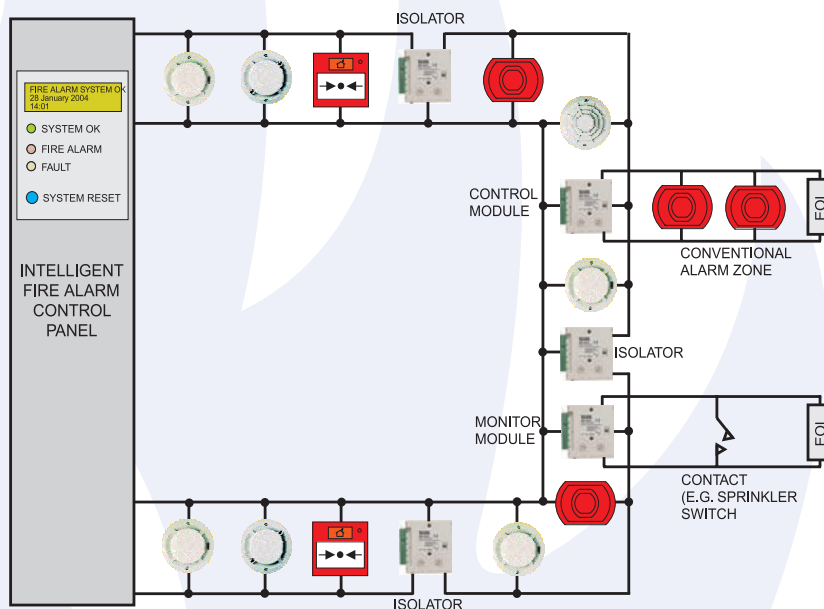

Figure 8: Intelligent fire alarm systems

intelligent system types

There are two methods commonly used for implementing intelligent fire systems:

The most common type of system is "Analogue". In this case the detector (or sensor) returns a value to the panel representing the current state of its sensing element(s).

The control panel compares this value with the alarm threshold in order to make the decision as to whether a fire is present. Note that the term analogue, used to describe these systems does not refer to the communication method (indeed many "analogue" fire systems use

digital communications) but to the variable nature of the response from the detector to the control panel.

In “Addressable” type intelligent systems, mainly used to meet the requirements of the French market, detector sensitivity is programmed to each device by the control panel or is preset in the factory.

The detector compares its current sensor value with the configured threshold to make the alarm decision, which is then transmitted to the panel when the sensor is interrogated.

In many systems the features offered by the two detection techniques are so similar that it is not particularly relevant which technique is used to make the alarm decision. It is better to select a system based on the features offered by the system as a whole.

communication protocol

Intelligent systems use the same pair of wires both to supply power to the loop, and to communicate with devices on the loop.

The communication language, or protocol used varies from

manufacturer to manufacturer, but generally comprises switching of the 24V supply voltage to other voltage levels to achieve communication.

A typical basic protocol comprises two main parts (See Fig 9): A query or poll of a device by the control panel including the device address and control information, and a response from the device giving its status and other information. Precise details of the information transferred will depend on the manufacturer, but normally will include:

Poll: Control Panel to device:

- Device address
- Control of device LED - blink to indicate polling, switch on when device is in alarm
- Control of device self-test
- Control of module output
- Error detection for example parity bit or checksum

Response: Device to Control Panel

- Device type (e.g. optical detector, heat detector, multi-sensor detector, module)

- Analogue Signal - i.e. the current sensor value
- Alarm Signal if appropriate
- Status of module output
- Remote test status
- Manufacturer code

Most commonly, each device on the loop will be polled in turn, however to increase speed around a loop, some protocols allow polling of groups of devices on a single communication.

Note that since different manufacturers have their own protocols, it is important to ensure compatibility between the detectors and control panel you intend to use. Some detector manufacturers produce intelligent detectors with different communication protocols for different customers, so two detectors which look virtually identical in appearance may not be compatible. Always check with the manufacturer of the control panel.

addressing methods

Different manufacturers of intelligent systems use a number of different methods of setting the address of a device, including:

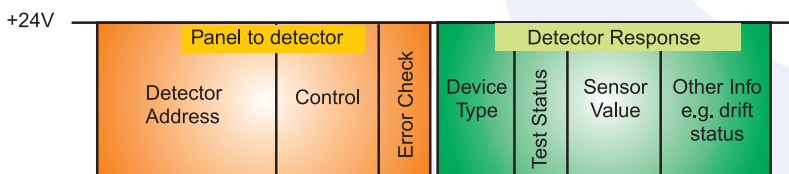

Figure 9: Typical protocol configuration



Figure 10: Decade address switches address 03 selected

- 7-bit binary or hexadecimal DIL switch
- Dedicated address programmer
- Automatic, according to physical position on the loop
- Binary 'address card' fitted in the detector base
- Decimal address switches

Using the Decimal Address Method differences in the protocol between detectors and modules allow them to have the same address without interfering with each other, and normally address 00 (the factory default setting) is not used within a system so that the panel can identify if a device address has not been set: Hence a total of up to 198 devices - 99 detectors and 99 modules (including call points,

sounders, input and output modules) may be connected to a loop.

system fault tolerance

Due to the looped wiring method used for analogue systems, they are more tolerant to open and short circuit wiring faults than conventional systems.

Under normal conditions, the loop will typically be driven only from one end. If the loop is broken (See figure 11.), the panel will detect the loss of communications with the detectors beyond the break, signal a fault, and switch to drive the loop from both ends. The system therefore remains fully operational, and can possibly even indicate the area of the break.

In order to give tolerance against short circuits on the loop, short circuit isolators are placed at intervals on the loop. Should a short circuit occur on the loop (Figure 12) the isolators directly on either side of the fault will isolate that section. The panel will detect the loss of the devices, signal a fault and drive the loop from both ends, thereby enabling the remainder of the loop to operate correctly and ensuring minimum loss of coverage.

Short circuit isolators are available as separate modules and incorporated into a detector base.

Some products have isolators built into each of the loop devices. With this configuration, since only the section of wiring between the two adjacent devices is isolated there will be no loss of coverage should a short circuit occur.

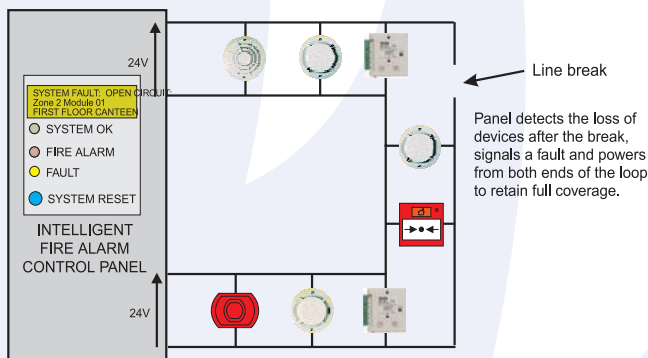

Figure 11: Open circuit fault

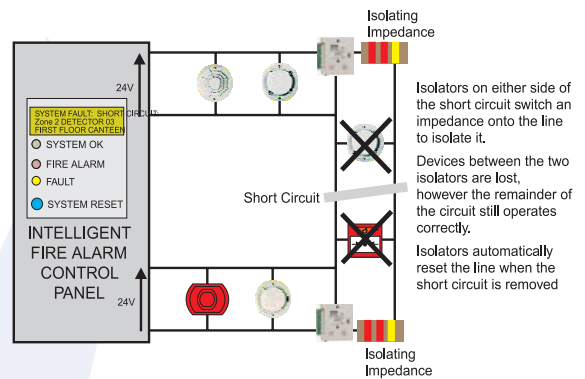

Figure 12: Short circuit fault

drift compensation and maintenance alarm

The sensitivity of a smoke detector tends to change as it becomes contaminated with dirt or dust (see figure 13). As contamination builds up, it usually becomes more sensitive, leading to the risk of a false alarm, but in some cases can

a “drift compensation” function, included in either the detector or the control panel algorithms. These functions use algorithms that monitor the sensitivity of a detector, and modify its response to compensate for a build up of dust in the chamber over time. Once the detector reaches the “drift limit” when the dirt build up can no longer be compensated for, a fault can be signalled. Some systems also incorporate a warning to signal that a detector is approaching its compensation limit and requires cleaning.

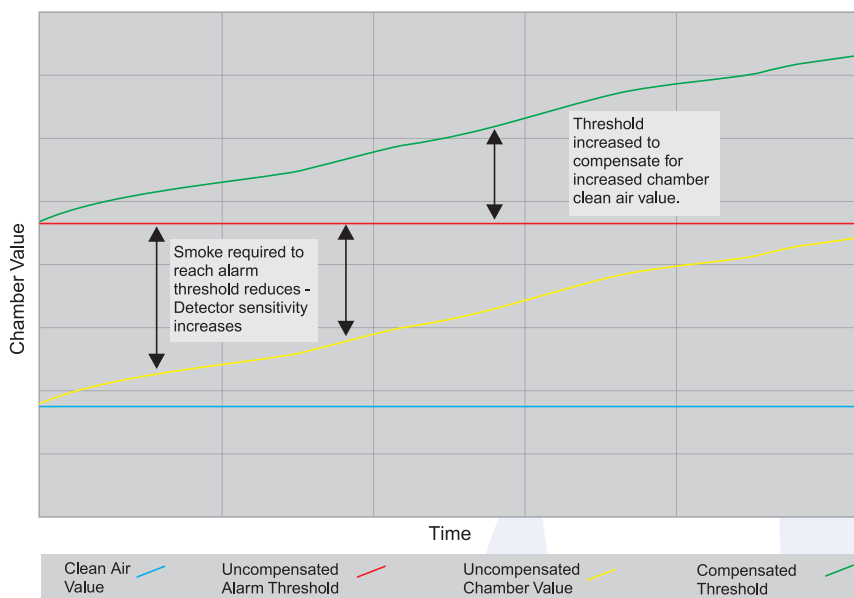

Figure 13: Chamber contamination and drift compensation

become less sensitive, so delaying the alarm if a fire is detected. To counter this, if a detector drifts outside its specification, a maintenance signal may be sent to the panel warning that the detector needs cleaning.

To further increase the maintenance interval, many systems incorporate

pre-alarm facility

One advantage of intelligent type systems is that since the data sent by a detector to the panel varies with the local environment, it can be used to detect when the device is approaching an alarm condition.

This “Pre-Alarm” can be signalled at the panel and can therefore be investigated to check if there is a real fire, or if it is caused by other signals, for example steam or dust from building work. This can avoid the inconvenience and expense of evacuating a building or calling out the fire brigade unnecessarily because of a nuisance alarm. The Pre-Alarm Threshold is typically set at 80% of the alarm threshold.

fire alarms

When a fire is detected, the control panel indicates an alarm by activating the fire indicator for the relevant zone on the control panel, sending a command to the relevant detector to illuminate its LED and activate alarm signals to start evacuation. Most intelligent fire system control panels include alphanumeric displays enabling them to show information on the source of the alarm. This may simply be a zone and detector address, or could be more descriptive for example “Smoke Detector, Bedroom 234”. The control panel may also use control modules to operate additional electrical equipment such as air conditioning units and door releases to prevent the spread of smoke and fire.

The alarm signals can either be a zone of conventional sounders and strobes activated via control modules on the loop or directly from the control panel, or addressable loop powered devices connected on the same loop as the detectors and

activated by direct command from the panel. Loop powered sounders tend to have lower wiring costs, however the number permissible on the loop may be restricted by current limitations.

On larger sites, it may be desirable to use zoned alarms. This allows a phased evacuation to be carried out, with areas at most immediate risk being evacuated first, then less endangered areas later.

fire system zones

Conventional fire alarm systems group detectors into 'zones' for faster location of a fire, with all the detectors in a particular zone being

connected on one circuit. Although intelligent systems allow the precise device that initiated an alarm to be identified, zones are still used in order to make programming the system and interpreting the location of a fire easier. The control panel may have individual fire indicators for each zone on the system, and the control panel response to an alarm is often programmed according to the zone of the device in alarm rather than its individual address.

The division of a loop into zones is achieved within the panel software, however, as multiple zones are physically connected onto the same cable, a short circuit can affect the operation of a large area of detection devices unlike a conventional system. BS5839 part 1

therefore recommends the division of the loop as to limit the effect of a short circuit with the use of short circuit isolators. The placement of these isolators should typically limit the loss of coverage to less than 2,000 m² nor more than one floor (figure 14). Allowances are made for the floor above and below but this is limited as not to affect more than five devices on these floors.

remote LED's

Most system smoke detectors are equipped with a terminal to allow the connection of a remote LED. Remote LEDs are often used outside bedroom doors in hotels so that in case of a fire, it is easy for the fire brigade to identify the location of the fire without the need to enter every room in the building. They may also be used where a detector is concealed in loft space, for example, to provide a visual indication that the detector is in an alarm state.

interface modules

Input and Output modules can be used to provide an interface between a fire loop and a variety of types of electrical equipment. Output or control modules can be used to operate sounders or shut down electrical equipment by command from the panel in case of a fire. Input or monitor modules are used to monitor volt-free switch contacts, for example from a sprinkler supervisory switch or an existing conventional fire panel.

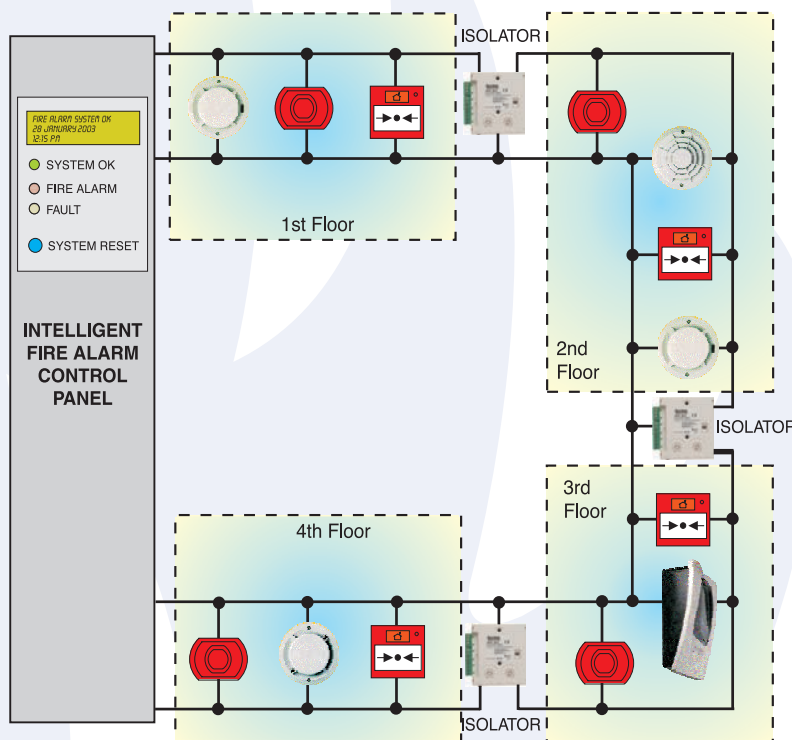

Figure 14: Intelligent system fire zones

Conventional zone monitor modules are also available, providing an interface between a zone of conventional detectors and an analogue fire detection loop, and are often used when existing conventional systems are upgraded.

programming of intelligent fire alarm panels

Most small intelligent systems can be programmed with ease without the need for any specialised equipment. The control panel has an alphanumeric keypad, which is used to enter data into the system. Typically a password is required to set the panel to 'engineering mode', allowing the panel to be programmed. Many control panels have an 'auto-learn' facility, whereby the control panel polls every address on the system, and detects which addresses have been used, and what type of detector or module has been connected to each address. As a default, the panel will usually programme all the devices on the loop into the same zone.

The user can then customise the system by entering how the zones are configured. The panel may give the user an option of how modules are to be configured - for example whether an input module should trigger an alarm or a fault when operated and whether the wiring is to be monitored for open circuit faults.

Other optional features may also be programmed using the keypad. The sensitivity of each detector on the system can be configured for high sensitivity if the detector is installed in a clean smoke-free area, or for low sensitivity if the area is subject to cigarette smoke, for example. Complex intelligent systems offer many user-programmable features that can be time-consuming to enter manually using the keypad. In this case, many panels have the facility to connect a portable PC by means of a serial data link.

The user is supplied with a specialised piece of software, which enables the entire configuration of the system to be programmed into the PC, away from site if necessary. It is then a simple matter of temporarily connecting the PC to the control panel and downloading the system configuration to the panel. Once the information has been downloaded, it is permanently stored in the control panel, and the PC can be removed.

advantages of intelligent systems

- The wiring cost of a system can be reduced by the use of a single pair of wires for many devices including smoke and heat detectors, call points, beam detectors, input and output modules.
- Intelligent Systems allow

the location of a fire to be precisely located from the control panel

- The use of looped wiring allows the system to function normally even with an open circuit in the loop wiring
- The use of short circuit isolators allows correct operation of most, if not all of the system even with a short circuit in the loop wiring
- Detectors are constantly monitored for correct operation
- The use of a 'pre-alarm' feature alerts staff to check whether a fire condition exists before the alarm is raised
- Different detector sensitivities can be used for diverse applications
- The use of addressable loop-powered sounders allows the same wiring to be used for sensors, call points and sounders
- The use of monitor modules allows contacts from sprinkler switches, existing fire alarm systems, fire dampers etc. to be monitored using detector loop wiring
- The use of control modules allows sounder lines, air conditioning systems, lifts etc. to be controlled or shut down using detector loop wiring

detector application guide

fire system categories

Before a fire protection system can be designed, it is necessary to define the main objectives of the system. This is normally determined by a fire risk assessment, and should be provided as part of the fire system specification. BS5839 Part 1: 2002 defines three basic categories of fire detection system.

category M systems

Category M systems rely on human intervention, and use only manually operated fire detection such as break glass call points. A category M system should only be employed if no one will be sleeping in the building, and if a fire is likely to be detected by people before any escape routes are affected. Any alarm signals given in a category M system must be sufficient to ensure that every person within the alarm area is warned of a fire condition.

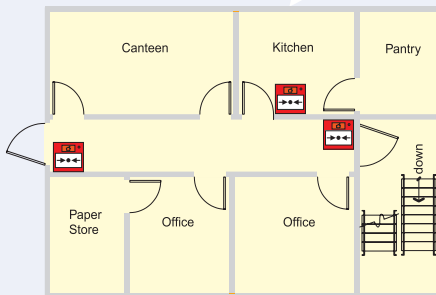

category L systems

Category L systems are automatic fire detection systems intended to protect life. The category is further subdivided as follows:

category L5: In a category L5 system certain areas within a building, defined by the fire system specification, are protected by automatic fire detection in order to reduce the risk to life. This category of system may also include manual fire protection.

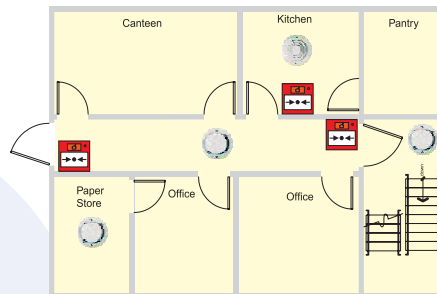

Example L5 System: L4 protection plus areas of high risk

category L4: Designed to offer protection to the escape routes from a building. The system should comprise Category M plus smoke detectors in corridors and stairways

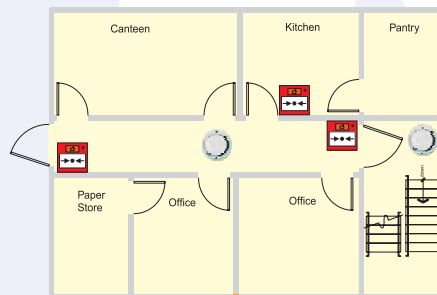

category L3: Intended to offer early enough notification of a fire to allow evacuation before escape routes become smoke logged.

Protection should be as for category L4 with the addition of smoke or heat detectors in rooms opening onto escape routes.

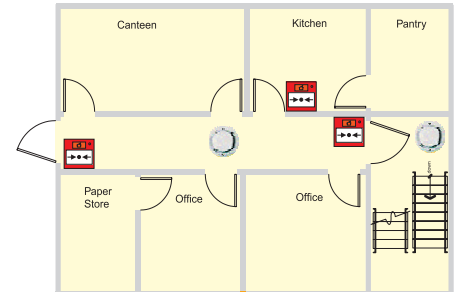

category L2: Objectives are similar to category L3, however additional protection is provided for rooms at higher risk. Protection should be as for category L3 plus smoke detectors in specified rooms at high risk

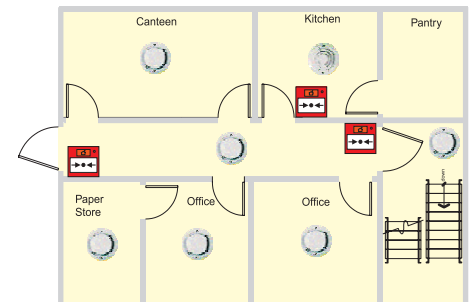

category L1 : The highest category for the protection of life. Intended to give the earliest possible notification of a fire in order to allow maximum time for evacuation. Automatic and manual fire detection installed throughout all areas of the building. Smoke detectors should be employed wherever possible to protect rooms in which people can be expected to be present.

Similarly to class M systems, all alarm signals given in a category L system must be sufficient to warn all those people for whom the alarm is intended to allow for a timely evacuation.

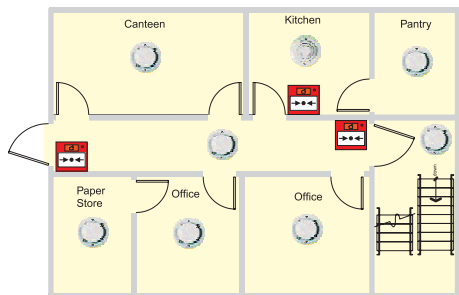

category P systems

Category P systems are automatic fire detection systems whose primary objective is to protect property. The category is subdivided as follows:

category P2: Intended to provide early warning of fire in areas of high hazard, or to protect high-risk property. Automatic fire detection should be installed in defined areas of a building.

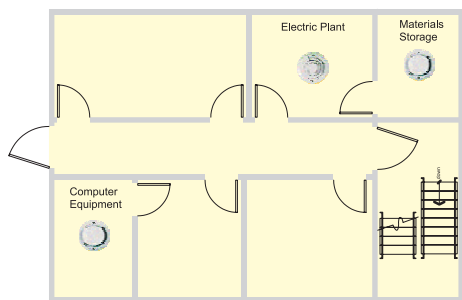

category P1: The objective of a category P1 system is to reduce to a minimum the time from the ignition of a fire to the arrival of the fire brigade. In a P1 system, fire

detectors should be installed throughout a building.

In a category P system, unless combined with category M, it may be adequate for alarm signals simply to allow fire fighting action to be taken, for example a signal to alert a responsible person to call the fire brigade.

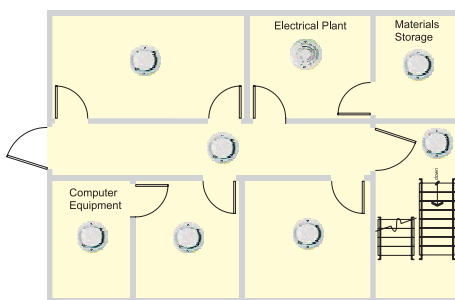

manual call points

People can often still detect a fire long before automatic fire detectors; hence manual call points are important components of fire detection systems in occupied buildings to ensure timely evacuation in the case of fire. All call points should be approved to EN54-11, and should be of type A, that is once the frangible element is broken or displaced the alarm condition is automatic.

Manual call points should be mounted on all escape routes, and at all exit points from the floors of a building and to clear air. It should not be possible to leave the floor of a building without passing a manual call point, nor should it be necessary to deviate from any escape route in order to operate a manual call point. Call points mounted at the exits from a floor may be mounted within the accommodation or on the stairwell. In multiple storey buildings where phased evacuation is to be used call points should be mounted within the accommodation to avoid activation of call points on lower levels by people leaving the building.

In order to provide easy access, call points should be mounted between 1.2 and 1.6m from the floor, and should be clearly visible and identifiable. The maximum distance anyone should have to travel in order to activate a manual call point is 45m, unless the building is occupied by people having limited mobility, or a rapid fire development is likely, in which case the maximum travel distance should be reduced to 20m. Call points should also be

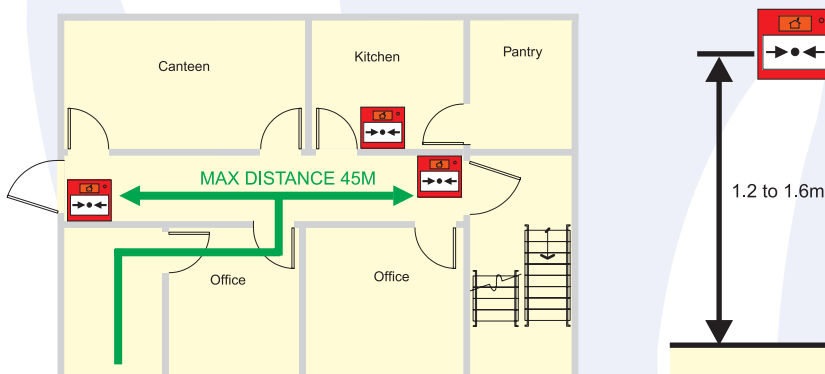

Figure 15: Intelligent system fire zones

sited in close proximity to specific hazards, for example kitchens or paint spray booths.

selection of automatic fire detectors

Smoke detectors are the most sensitive automatic means of detecting a fire and should be used wherever conditions allow.

ionisation smoke detectors

Ionisation smoke detectors use a weak radioactive source to ionise the air between two electrodes, creating positive and negative ions and so allowing a small current to flow across the chamber. Smoke particles attract these ionised particles, and allow positive and negative ions to recombine, thus reducing the number of ions and hence the current flow.

Environmental regulations concerning the radioactive source used in ion detectors means that they are now becoming obsolete, and most major manufacturers are no longer including ionisation detectors in new ranges.

photoelectric smoke detectors

Photoelectric or optical smoke detectors work by generating pulses of infra red light and measuring any diffracted light. If smoke is present in the sensing chamber, the light is diffracted by the smoke particles onto a photodiode, which senses the presence of the smoke (see

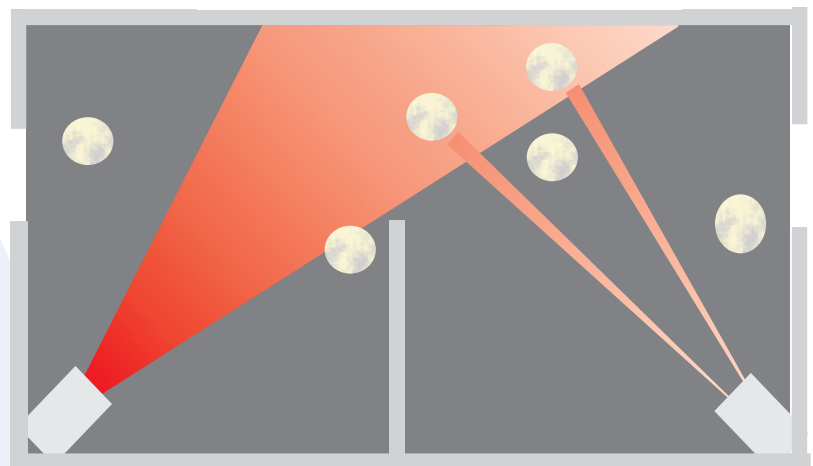

figure 16). They are now largely replacing ionisation detectors as a general purpose detector.

Photoelectric smoke detectors are tested across the complete range of EN54 fires, however they are most sensitive to smoke containing large particles from around 0.4 to 10 microns, such as that given off by smouldering fires. A photoelectric detector would therefore be a good

choice in an environment where a slow burning fire could be expected, such as a room containing modern fabrics and furnishings.

multi-criteria detectors

Multi-criteria detectors comprise of two or more sensors within the same housing, integrated by the detector electronics or software to give a rapid response to a broader range

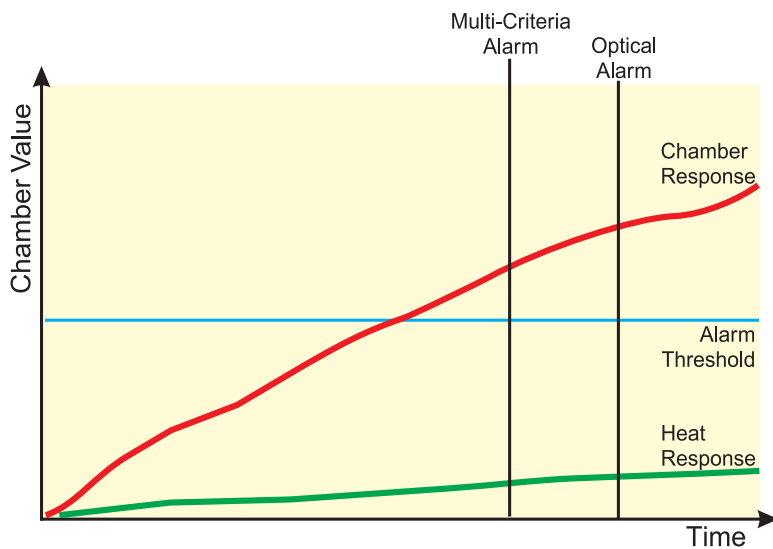

Figure 17: Photo-thermal detector response

of fires and greater immunity to nuisance alarms. The most common type at present is a combination of optical and rate of rise heat sensors, which can give a response to fast flaming fires similar to that of ionisation detectors. Other sensor combinations are also available.

CO detectors

A recent addition to BS5839 is CO detectors. These generally use an electro-chemical sensor to detect carbon monoxide given off by incomplete combustion. They provide reliable detection of incipient fires whilst giving good assurance against nuisance alarms. However the chemical cells used in these detectors have a limited life span, and they cannot detect fast burning fires due to the low CO levels produced.

heat detectors

Heat detectors are normally used in

environments where a smoke detector might generate false alarms, for example kitchens or shower rooms.

Rate of Rise heat detectors will alarm if the temperature rises very quickly, or if the temperature

reaches a set threshold. This type of detector would be the first choice in an environment where a smoke detector could not be used.

In some environments, such as boiler rooms, fast rates of rise of temperature can be expected normally, meaning that there would be a risk of false alarms when using a rate-of-rise device. In this case a fixed temperature detector would be suitable. As their name implies, fixed temperature detectors give an alarm once the temperature has reached a preset threshold, most commonly 58°C or 78°C for EN54-5 Class AS or BS respectively.

optical beam detectors

Optical beam detectors work on the principle of projecting a beam of light across a room, which is attenuated when smoke is present thus allowing an alarm to be given

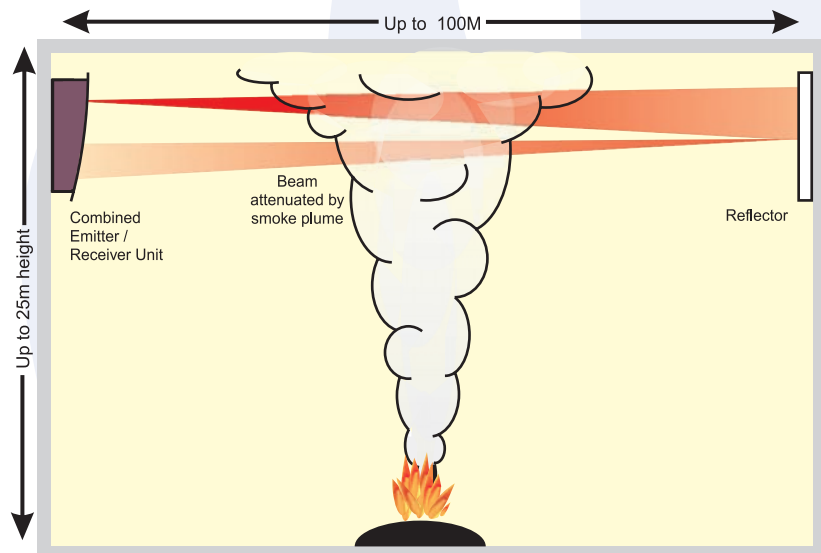

Figure 18: Operation of reflective type optical beam smoke detector

(Figure 18). There are two forms of beam detector: emitter and receiver separate (single path), requiring separate wiring both to the emitter and receiver, and reflective in which the emitter and receiver are mounted in the same box, and the beam is shone onto a reflective material at the far side of the room (dual path).

Since an optical beam detector senses smoke across the entire smoke plume, it tends to be less affected by smoke dilution as the ceiling height increases than point type smoke detectors. In addition, a single beam detector can protect a large area; hence they are particularly suitable for protecting large high rooms such as sports

arenas, warehouses and shopping malls.

Beam detectors are more complex to install than ordinary point smoke detectors and it is advisable to consult an application guide for the use of projected beam smoke detectors before considering the use of these detectors.

Detector type	Application	Not suitable for
Ionisation smoke detector	General purpose smoke detector – better for fast flaming fires	Areas subject to smoke, steam, dust or dirt during normal use
Optical smoke detector	General purpose smoke detector – better for smouldering fires	Areas subject to smoke, steam, dust or dirt during normal use
Photo-thermal multi-criteria detector	General purpose detector – good for smouldering and fast flaming fires	Areas subject to smoke, steam, dust or dirt during normal use
Optical beam smoke	Large and high rooms	Areas subject to smoke, steam, dust or dirt during normal use
Rate of rise heat detector	Areas subject to smoke, steam, dust or dirt during normal use	Areas subject to rapid changes of temperature or temperature over 43°C
Fixed temperature detector (58°C)	Areas subject to smoke, steam, dust or dirt and rapid changes of temperature during normal use	Areas subject to temperatures over 43°C
High temperature fixed detector (78°C)	Areas subject to smoke, steam, dust or dirt and temperatures over 43°C during normal use	Areas subject to temperatures over 70°C

Figure 19: Selection of fire detectors

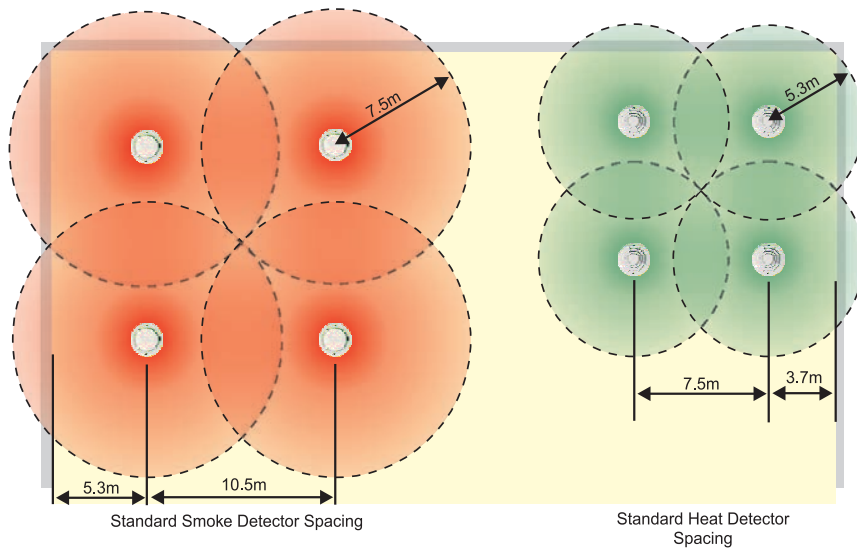

Figure 20: Simple spacing plans for smoke and heat detectors

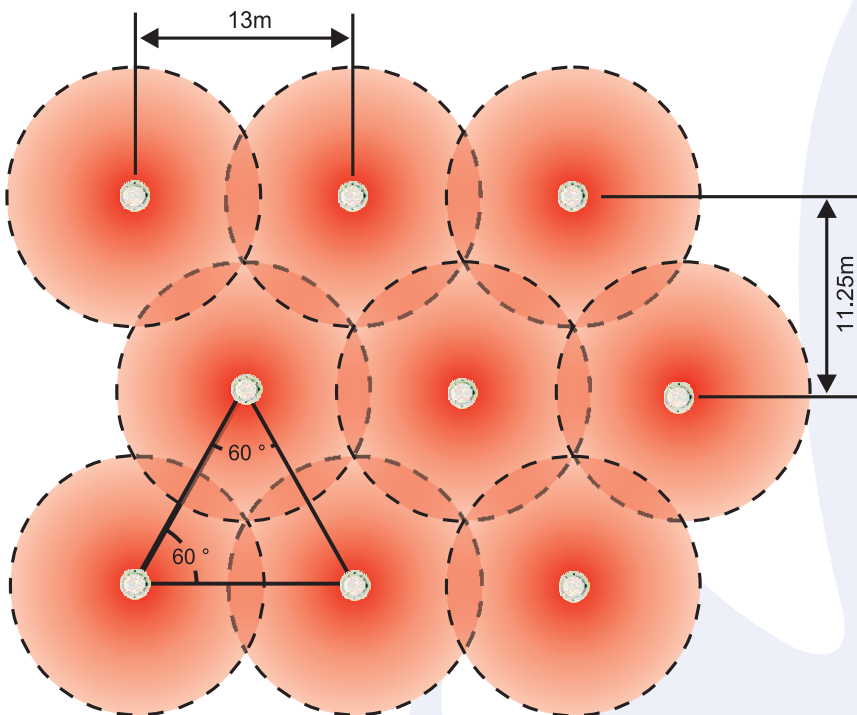

Figure 21: Alternate smoke detector spacing plan for protecting large areas

location and spacing of automatic fire detectors

It is important to consult applicable local and national standards when choosing the spacing and location of fire detectors. The following information is intended only as a guide to the location and spacing of detectors. There is currently no European standard available; hence this guide is based on BS5839 part 1, 2002.

location and spacing of point fire detectors on flat ceilings

On a flat ceiling with no obstructions, the radius of protection of fire detectors is 7.5m for a smoke detector and 5.3m for a heat detector, and detectors should be mounted a minimum of 0.5m from a wall. Some analogue multi-criteria detectors have a heat sensor only function, switched by the control panel, typically used to reduce the possibility of false alarms during daytime when a building is occupied, reverting to multi-sensor operation at night time. If this type of operation is employed, the radius of protection for a heat sensor should be used. Figure 20 gives a simple spacing plan based on these figures, however it should be noted that this might not be the most efficient layout for a given site; for example in larger areas, it is also possible to use a staggered layout, see figure 21, which may reduce the number of detectors required. In practice, the layout of the room must be considered to obtain the most efficient detector layout.

ceiling height

Smoke or heat detectors can only detect fires once a certain amount of smoke or heat has reached the sensor. As the height of a ceiling increases, the time taken for smoke or heat to reach a sensor will increase, and it will become diluted with clean, cool air. As a result, maximum ceiling heights are limited as indicated in figure 22 below.

Detector type	Maximum ceiling height
Point smoke detector conforming to EN54-7	10.5m
Heat detector conforming to EN54-5 Class A1 (threshold 58°C)	9m
High temperature heat detector conforming to En54-5 Class B (threshold 78°C)	6m
Optical beam detectors	25m

Figure 22: Maximum ceiling height for different types of detector

Often, a boundary layer can form close to the ceiling, which is free of smoke and remains cool. To avoid this, and maximise the probability of detection, smoke detectors should normally be mounted with their smoke entry 25mm-600mm below the ceiling, and heat detectors should be mounted with their heat element 25mm-150mm below the ceiling. Detector design normally ensures that the minimum

requirement is met, but care needs to be taken if the detectors are to be stood away from the roof, for example mounting on an open lattice suspended ceiling.

Another problem that should be considered is the possibility of stratification of the air in a room into hot and cold layers, causing the smoke or heat to stop at the boundaries. This particularly affects high rooms or atria, where beam detectors are often used. Stratification is very difficult to predict, and can vary, even within the same room as environmental conditions change.

ceiling obstructions

Ceiling obstructions such as beams greater than 10% of the ceiling height should be treated as a wall, and will thus divide a room. Detectors should not be mounted within 500mm of such an obstruction.

If the depth of an obstruction such as a beam is less than 10% of the height of the ceiling, but greater than 250mm deep, then detectors should not be mounted any closer than 500mm to the obstruction.

Where an obstruction such as a beam or a light fitting is less than 250mm in depth, detectors should not be mounted any closer to the obstruction than twice its depth (see figure 23)

Where a ceiling comprises a series of small cells, for example a honeycomb ceiling, or a series of closely spaced beams, for example floor of ceiling joists, the recommended spacing and siting of detectors changes further, dependant on the ceiling height and the depth and spacing of the beams. Reference should be made to relevant standards for details (in the UK BS5839 Part 1: 2002, 22.3.k figure 3 and 19).

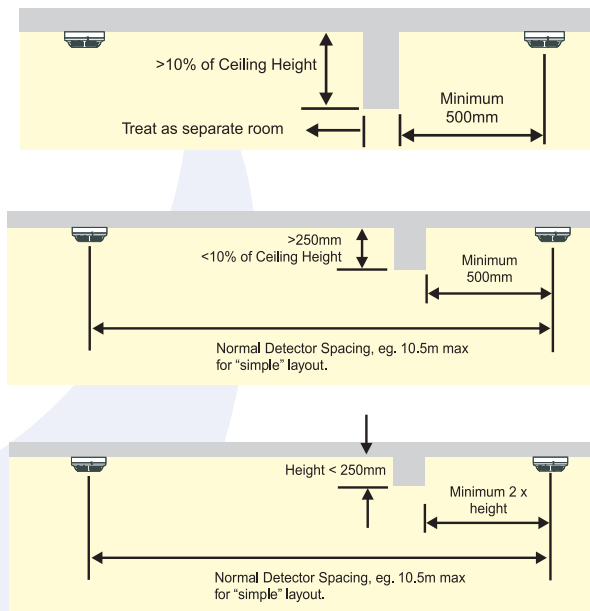

Figure 23: Detector spacing around isolated ceiling obstructions

partitions and racking

Where the gap between the top of a partition or section of racking and the ceiling is greater than 300mm, it may be ignored. If the gap is less than 300mm it should be treated as a wall.

To maintain a free flow of smoke and heat to the detector, a clear space should be maintained for 500mm in all directions below the detector.

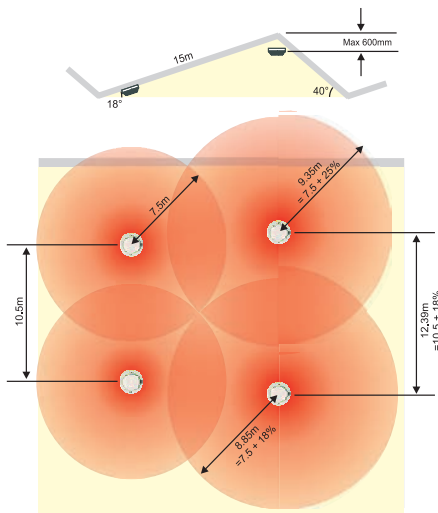

Figure 24: Spacing of smoke detectors under a pitched roof

sloping ceilings

Where the ceiling is pitched or sloping, the slope of the roof tends to speed the rise of smoke or heat to the apex, hence reducing the delay before the detectors are triggered. For sloped roofs with a pitch height greater than 600mm for smoke detectors, or 150mm for heat detectors, a row of detectors should be placed within a maximum vertical distance of 600mm or 150mm for smoke or heat detectors respectively from the roof apex. Sloped roofs rising less than 600mm for smoke detectors or 150mm for heat detectors may be treated as a flat ceiling.

Since the smoke or heat tends to rise faster up the slope, it is permissible to use a greater spacing for the row of detectors mounted in the apex of the roof: For each degree of slope of the roof, the spacing may be increased by 1% up to a maximum of 25%. Where, as in figure 24, the roof slopes are unequal the spacing down the slopes can be unequal, however along the roof apex spacing the lesser of the two figures should be

used, in this example 10.5m +18%. Where the slope finishes within the adjusted detection radius, the standard distance to the next row of detectors, 10.5m, should be used. Care must be taken when placing the next row that no gaps are left in detection coverage.

corridors

In corridors less than 2m wide, detectors should be spaced at a distance of 15m for smoke detectors and 10.6m for heat detectors, with the maximum dimension to a wall at the end of the corridor being 7.5m and 5.3m respectively.

In narrow rooms and corridors greater than 2m wide, due to the way that the coverage radii of detectors intersect with the walls of the corridor, the spacing between detectors will increase. Figure 25 shows how, for a room 6m wide, the spacing for smoke detectors can be increased from the standard 10.5m.

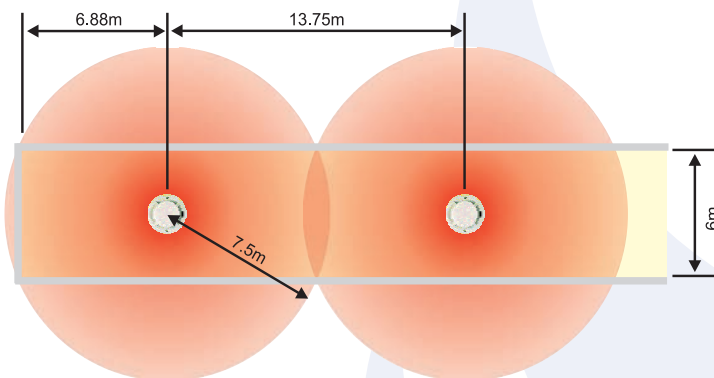

Note: Detectors are mounted in the centre line of the room

Figure 25: Smoke detector spacing in corridors greater than 2m wide

stairwells and lift shafts

Internal stairwells and lift shafts and other vertical service ducts through a building provide a clear path for smoke to pass between floors of a building as if they were chimneys. It is therefore important to protect these, preferably using smoke detectors.

All vertical shafts through a building must be protected by a smoke or heat detector at the top of the shaft, and by a detector within 1.5m of each opening onto the shaft.

In internal stairways, a detector should be mounted on each main landing (Figure 26). In addition, if the detectors on the landings are separated by more than 10.5m, intermediate detectors should be mounted on the underside of the stairs.

Detectors should also be fitted into any room opening directly onto a stairway other than a WC cubicle.

voids and false ceilings

Detectors need not normally be installed in voids less than 800mm deep, unless on the basis of a fire risk assessment it is thought that fire or smoke could spread

extensively through the voids before detection, or unless the fire risk in the void is such as to warrant protection. Use of heat and smoke detectors in voids greater than 800mm high is dependant on the protection category, and fire risk assessment.

Where they are installed into voids, a detector's sensing element should be mounted either in the top 10% or the top 125mm of the void space whichever is greater. Although it can be difficult to install detectors the correct way up in void spaces, care should be taken as incorrect orientation of a detector can lead to increased ingress of dirt and dust, leading to reduced

maintenance intervals, and possible nuisance alarms.

Detectors above a false ceiling may be used to protect the area below it, if the false ceiling is perforated uniformly across the complete area of the ceiling, with the holes making up over 40% of the ceiling surface area, having a minimum size of 10mm and the false ceiling having a thickness of less than three times the dimensions of the perforations.

In all other cases, the areas above and below a false ceiling should be treated as separate, and thus should be protected separately with detectors below the ceiling, and if necessary in the void above the ceiling.

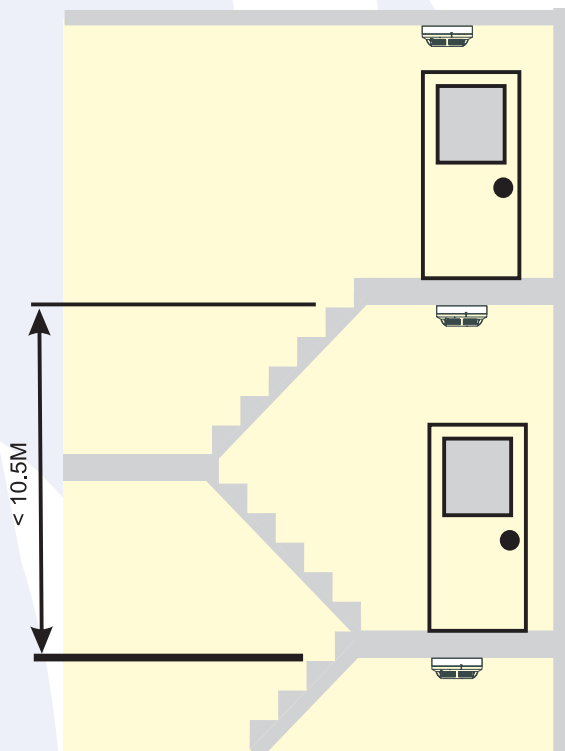

Figure 26: Detector in stairwells

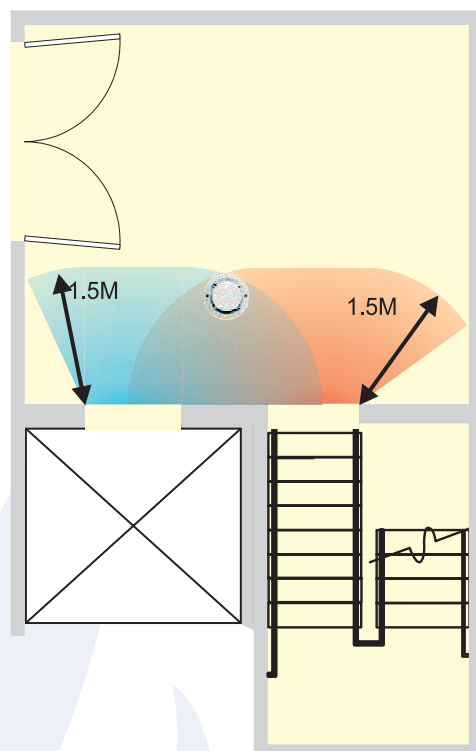

Figure 27: Protection of vertical shafts

lantern lights

A detector should be mounted in any lantern light used for ventilation or having a height exceeding 800mm. The temperature in lantern lights can change rapidly owing to heating by sunlight, which means that rate-of-rise heat detectors should not be used and heat detectors should be protected from direct sunlight.

location and spacing of optical beam detectors

Generally, for an optical beam detector mounted within 600mm of a ceiling, the fire detection coverage is up to 7.5m either side of the beam (Figure 28). The beam of the

detector should not be closer than 500mm to any obstruction. Similar recommendations to above apply to the application of beam detectors with sloped ceilings, voids, false ceilings, walls and partitions and ceiling obstructions.

Where it is likely that people will be present in an area protected by beam detectors, the detectors must be mounted at a minimum height of 2.7m, and consideration must also be given to the possibility of other temporary obstructions to the beam such as forklift trucks.

For further information on the use and mounting of beam detectors, see Beam Detector Guide.

alarm signals

audible alarm signals

Audible fire alarm signals must provide a clear warning of a fire to all those for whom the signal is intended. For category M and L systems this would normally imply all occupants of a building, however in some sites this may not apply, for example in hospitals or rest homes, residents might need assistance to evacuate, in which case it may be sufficient to alert staff.

The general requirement for the volume of audible alarm signals is that they should provide a Sound Pressure Level (SPL) of at least 65dB(A), but not more than

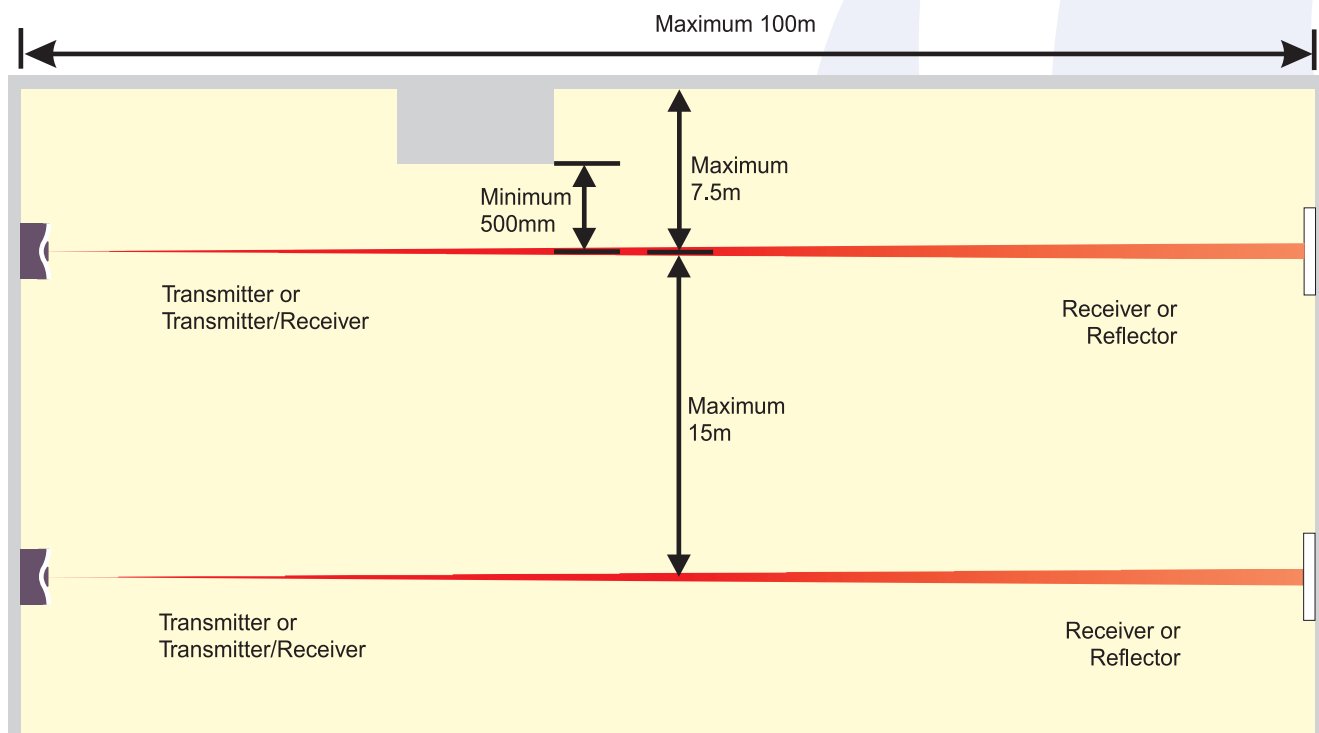

Figure 28: Smoke detector spacing in corridors greater than 2m wide

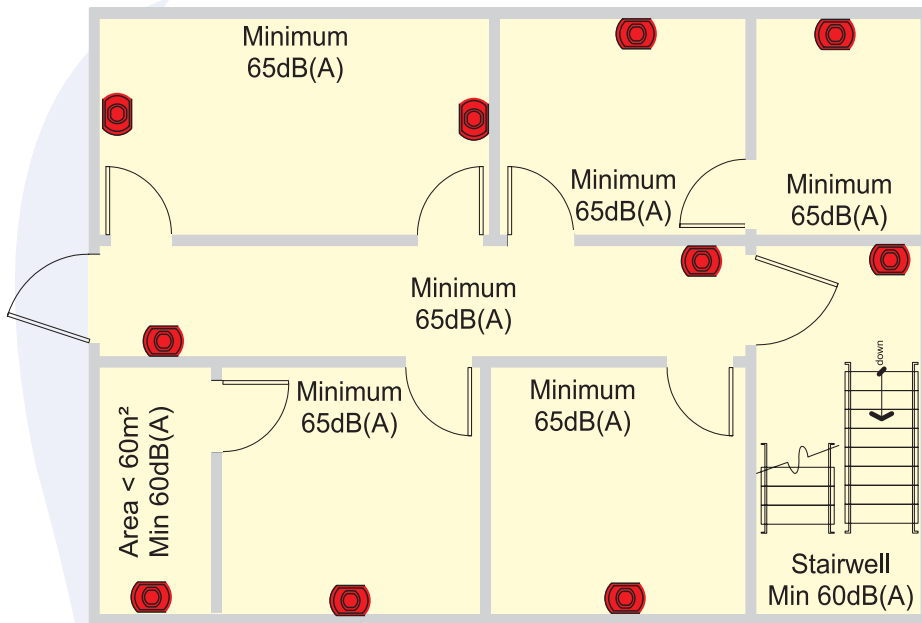

Figure 29: General fire alarm sound pressure levels

120dB(A) throughout all accessible areas of a building. See figure 29.

Exceptions to this general rule are as follows:

- In stairways the SPL may be reduced to 60dB(A)
- Enclosures less than 60m may be reduced to 60dB(A)
- There is no minimum for enclosed areas less than 1m²
- At specific points of limited extent the SPL may be reduced to 60dB(A)

Where a continuous background noise level greater than 60dB(A) is present the fire alarm signal should be 5dB above the ambient, but not greater than 120dB(A).

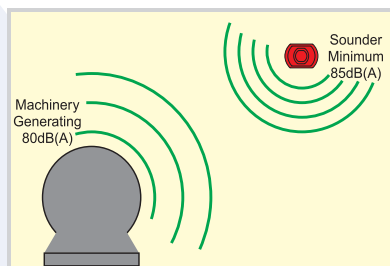

Where the alarm is intended to wake people, an SPL of 75dB(A) is required at the bed head. Generally this will require a sounder to be placed within the room.

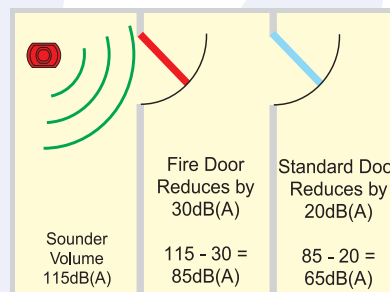

Where it is not possible to place a sounder within a room, there will be a loss of approximately 20dB(A) through a standard door, and 30dB(A) through a fire door.

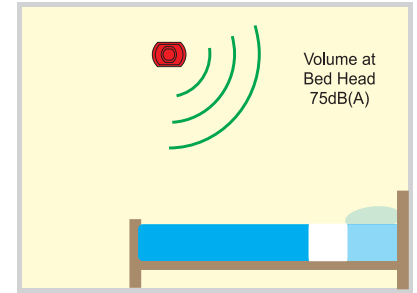

Warning: Volumes greater than 120dB(A) will cause damage to hearing.

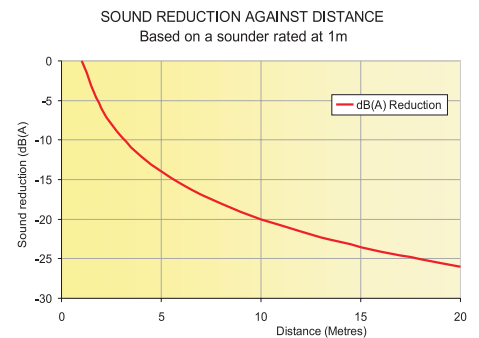

In open space, as the distance from a sounder doubles, the sound level will be reduced by 6dB(A), as shown.

It is preferable to use multiple quieter sounders to achieve the required sound level, rather than a smaller number of loud devices. This is to prevent points of excessive volume, which may lead to disorientation or damage to hearing. Two sounders providing equal sound levels will combine to add 3dB(A) to the SPL.

visual alarm signals

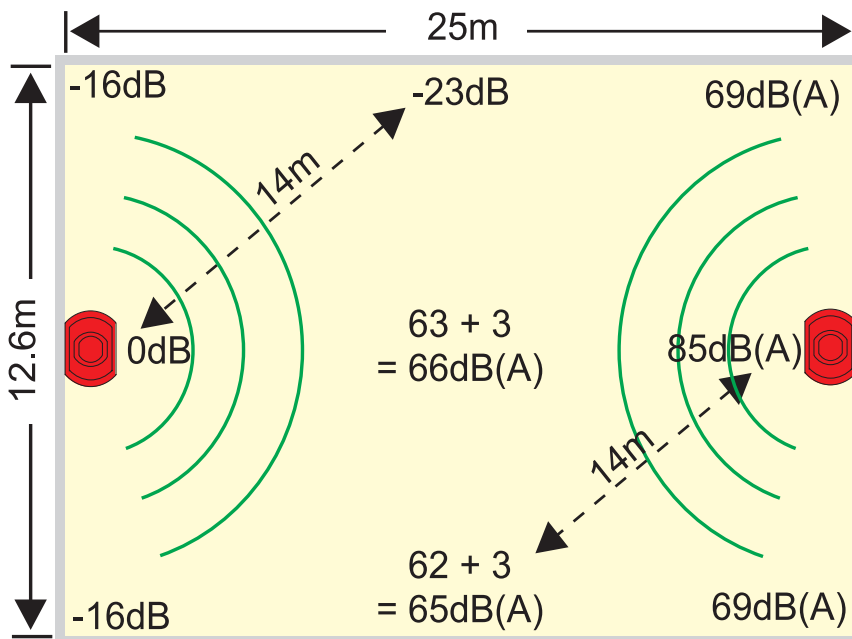

Note: dB(A) figures are for example only. Left side represents attenuation; right side indicates typical sound pressure level

Visual alarms are required in order to satisfy the Disability Discrimination Act (DDA) as well as being used in areas of high background noise where hearing protection is likely to be worn. Just as audible alarms should be placed throughout all accessible areas of a building, visual alarms should be placed such that they can be seen in order to alert the hearing impaired.

Visual alarms should be clearly distinguishable from other warning lights, preferably red and should flash at a rate of 30 to 130 flashes per minute. The recommended mounting height is above 2.1m, however they should not be mounted closer than 150mm from the ceiling. They should be

positioned so that any alarm is clearly visible from all locations within the area protected.

maintenance of fire detectors

Caution: Prior to carrying out any maintenance or testing on a fire alarm system, the relevant authorities and staff should be notified.

Over time, the sensitivity of a smoke detector can change owing to a build-up of dirt in the detector chamber. In most modern detectors this effect is slowed by the inclusion of drift compensation functions,

however the build up can still lead to a risk of false alarms or change in the detector sensitivity.

The frequency of maintenance requirements on a detector will depend on site conditions, obviously the dirtier the site the more frequent maintenance will be required. The optimum frequency for a given site should be determined over a period of time after the commissioning of the fire system.

Some detectors (smoke, heat, or multi-criteria) are designed such that they can be easily dismantled for maintenance. Normally it is sufficient to use compressed air or a vacuum cleaner to remove dust from the detector chamber.

Once maintenance on a fire detection system has been completed, it should be re-tested.

routine functional testing of fire detectors

BS5839 Part 1: 2002 gives a range of recommendations regarding routine testing of a fire detection system.

A weekly test should be carried out on a fire detection system by activating a manual call point to ensure that all fire alarm signals operate correctly, and that the appropriate alarm signals are clearly received. This test should be carried

out at approximately the same time each week, using a different call point in rotation.

In order to comply with BS5839 Part 1: 2002, periodic inspections, servicing and functional tests of the fire alarm system should be carried out at intervals determined by an assessment of the site and type of system installed, not normally greater than six months.

It is recommended to perform regular functional tests on all fire detectors annually. These annual tests may be carried out over the course of two or more service visits during the twelve-month period.

Codes and standards (in the UK BS5839 Part 1:2002, Section 6) now require functional tests to introduce smoke through the smoke detector vents and into the sensing chamber. It also calls for heat detectors to be tested by means of a suitable heat source, and not by a live flame. CO fire detectors now also need to be functionally tested by a method that confirms that carbon monoxide can enter the chamber.

Many installers use a set of equipment that consists of a complete range of test tools that locate on the end of the pole in order to aid compliance with codes. Tools exist for testing smoke, heat, and CO fire detectors, whilst also enabling them to be accessed and removed at height.

Using functional test equipment, along with those maintenance tools should ensure that the system remains at its optimum operation for many years.

MORLEY  **IAS**

FIRE SYSTEMS

by Honeywell

Charles Avenue
Burgess Hill
West Sussex
RH15 9UF

T:+44 (0) 1444 235 556
F:+44 (0) 1444 254 410
E:sales@morley-ias.co.uk
www.morley-ias.co.uk

